

PIPISTRELLO LED

code: **620/DIM/L/1/AL**

DESIGN **GAE AULENTI** 1965



TABLE OR STANDING LAMP WITH DIFFUSED LIGHT, ADJUSTABLE HEIGHT WITH TELESCOPIC MOVEMENT. GLAZED STAINLESS STEEL TELESCOPE. WHITE OPAL METHACRYLATE DIFFUSER. BASE AND KNOB: DARK BROWN /MA, WHITE /BI, PURPLE RED /RO, SATIN ALUMINIUM /AL, BRIGHT BLACK /NE - COPPER /CU, GOLD /ORO AND IN TITANIUM /TI COLOURS. LED LIGHT SOURCE INTEGRATED. ELECTRONIC DIMMABLE DRIVER ON THE PLUG.

TECHNICAL DRAWINGS

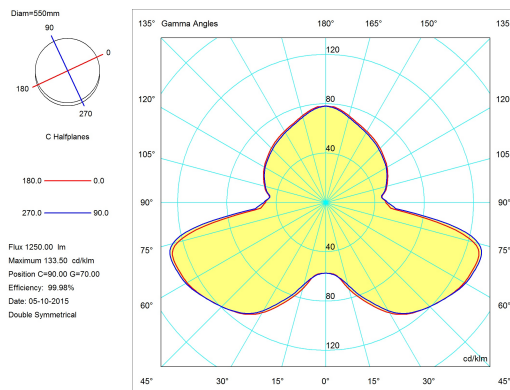
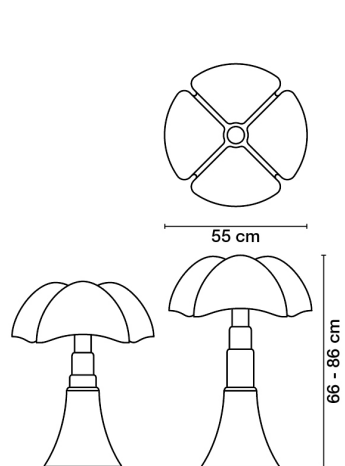

UTILIZATION:	INTERNAL	TIPOLOGY:	TABLE LAMPS	
COLOURS	STRUCTURE: DIFFUSER:	SATIN ALUMINIUM WHITE		
MATERIALS	STRUCTURE: DIFFUSER:	STAINLESS STEEL OPAL WHITE METHACRYLATE		
MEASURES	WIDTH: - HEIGHT: 66 - 86 cm LENGTH: - DEPTH: -	DIAMETER: 55 cm HOLE DIAMETER: - HOLE DEPTH: -	WEIGHT NET: 10 KG GROSS: 14 KG	
	PACKAGING VOL.M ³ : 54X54X26 - 41X41X78		NUMBER OF ITEMS: 2	
BULBS	LED 1X14W FLUX: 1400LM KELVIN: 2700° CLASS: A++ CRI: - COLOR TOLERANCE: - DURATION: -			
DEVICE SPECIFICATIONS	TYPE OF EMISSION: DIFFUSED POWER: 14 W FLOW LAMP: 1249 lm BEAM ANGLE: - DEVICE EFFICIENCY: 89.2lm/W IMPACT RESISTANCE: - GLOW WIRE TEST: -		POWER SUPPLY CABLE LENGTH: 45+200cm LENGTH OF HANGING CABLE: - SUPPLY: INCLUDED POWER SUPPLY ASSEMBLY: EXTERNAL TYPE OF DIMMING: DIMMER ON CABLE VOLTAGE: 230 V	
	POWER SUPPLY: ELECTRONIC DIMMABLE POWER SUPPLY			
CERTIFICATIONS				
MARKETS	THIS ITEM IS AVAILABLE IN THE FOLLOWING COUNTRIES: EUROPE, USA & CANADA			

PIPISTRELLO LED

code: *620/DIM/L/1/AL*

DESIGN **GAE AULENTI** 1965

PHOTO GALLERY



PIPISTRELLO LED

code: **620/DIM/L/1/BI**

DESIGN **GAE AULENTI** 1965



TABLE OR STANDING LAMP WITH DIFFUSED LIGHT, ADJUSTABLE HEIGHT WITH TELESCOPIC MOVEMENT. GLAZED STAINLESS STEEL TELESCOPE. WHITE OPAL METHACRYLATE DIFFUSER. BASE AND KNOB: DARK BROWN /MA, WHITE /BI, PURPLE RED /RO, SATIN ALUMINIUM /AL, BRIGHT BLACK /NE - COPPER /CU, GOLD /ORO AND IN TITANIUM /TI COLOURS. LED LIGHT SOURCE INTEGRATED. ELECTRONIC DIMMABLE DRIVER ON THE PLUG.

TECHNICAL DRAWINGS

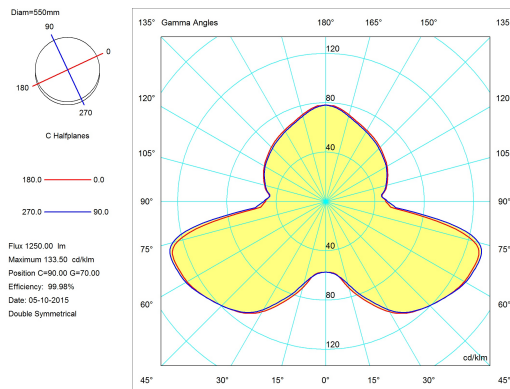
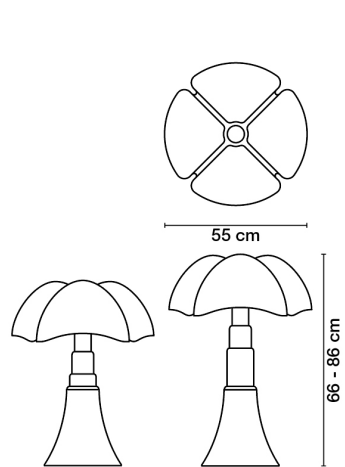

UTILIZATION: **INTERNAL**

TYOLOGY: **TABLE LAMPS**



COLOURS STRUCTURE:
DIFFUSER:

**WHITE
WHITE**

MATERIALS STRUCTURE:
DIFFUSER:

**STAINLESS STEEL
OPAL WHITE METHACRYLATE**

MEASURES WIDTH: -
HEIGHT: **66 - 86 cm**
LENGTH: -
DEPTH: -

DIAMETER: **55 cm**
HOLE DIAMETER: -
HOLE DEPTH: -

WEIGHT NET: **10 KG**
GROSS: **14 KG**

PACKAGING VOL.M³: **54X54X26 - 41X41X78**

NUMBER OF ITEMS: **2**

BULBS

LED 1X14W
FLUX: 1400LM
KELVIN: 2700°
CLASS: A++
CRI: -
COLOR TOLERANCE: -
DURATION: -



DEVICE SPECIFICATIONS

TYPE OF EMISSION: **DIFFUSED**
POWER: **14 W**
FLOW LAMP: **1249 lm**
BEAM ANGLE: -
DEVICE EFFICIENCY: **89.2lm/W**
IMPACT RESISTANCE: -
GLOW WIRE TEST: -

POWER SUPPLY CABLE LENGTH: **45+200cm**
LENGTH OF HANGING CABLE: -
SUPPLY: **INCLUDED**
POWER SUPPLY ASSEMBLY: **EXTERNAL**
TYPE OF DIMMING: **DIMMER ON CABLE**
VOLTAGE: **230 V**

POWER SUPPLY: **ELECTRONIC DIMMABLE POWER SUPPLY**

CERTIFICATIONS



MARKETS

THIS ITEM IS AVAILABLE IN THE FOLLOWING COUNTRIES:
EUROPE, USA & CANADA

PIPISTRELLO LED

code: *620/DIM/L/1/BI*

DESIGN **GAE AULENTI** 1965

PHOTO GALLERY



PIPISTRELLO LED

code: **620/DIM/L/1/CU**

DESIGN **GAE AULENTI** 1965



TABLE OR STANDING LAMP WITH DIFFUSED LIGHT, ADJUSTABLE HEIGHT WITH TELESCOPIC MOVEMENT. GLAZED STAINLESS STEEL TELESCOPE. WHITE OPAL METHACRYLATE DIFFUSER. BASE AND KNOB: DARK BROWN /MA, WHITE /BI, PURPLE RED /RO, SATIN ALUMINIUM /AL, BRIGHT BLACK /NE - COPPER /CU, GOLD /ORO AND IN TITANIUM /TI COLOURS. LED LIGHT SOURCE INTEGRATED. ELECTRONIC DIMMABLE DRIVER ON THE PLUG.

UTILIZATION: **INTERNAL**

TPOLOGY: **TABLE LAMPS**



COLOURS STRUCTURE:
DIFFUSER:

**COPPER
WHITE**

MATERIALS STRUCTURE:
DIFFUSER:

**STAINLESS STEEL
OPAL WHITE METHACRYLATE**

MEASURES WIDTH: -
HEIGHT: **66 - 86 cm**
LENGTH: -
DEPTH: -

DIAMETER: **55 cm**
HOLE DIAMETER: -
HOLE DEPTH: -

WEIGHT NET: **10 KG**
GROSS: **14 KG**

PACKAGING VOL.M³: **54X54X26 - 41X41X78**

NUMBER OF ITEMS: **2**

BULBS

LED 1X14W
FLUX: 1400LM
KELVIN: 2700°
CLASS: A++
CRI: -
COLOR TOLERANCE: -
DURATION: -



DEVICE SPECIFICATIONS

TYPE OF EMISSION: **DIFFUSED**
POWER: **14 W**
FLOW LAMP: **1249 lm**
BEAM ANGLE: -
DEVICE EFFICIENCY: **89.2lm/W**
IMPACT RESISTANCE: -
GLOW WIRE TEST: -

POWER SUPPLY CABLE LENGTH: **45+200cm**
LENGTH OF HANGING CABLE: -
SUPPLY: **INCLUDED**
POWER SUPPLY ASSEMBLY: **EXTERNAL**
TYPE OF DIMMING: **DIMMER ON CABLE**
VOLTAGE: **230 V**

POWER SUPPLY: **ELECTRONIC DIMMABLE POWER SUPPLY**

CERTIFICATIONS



MARKETS

THIS ITEM IS AVAILABLE IN THE FOLLOWING COUNTRIES:
EUROPE, USA & CANADA

TECHNICAL DRAWINGS

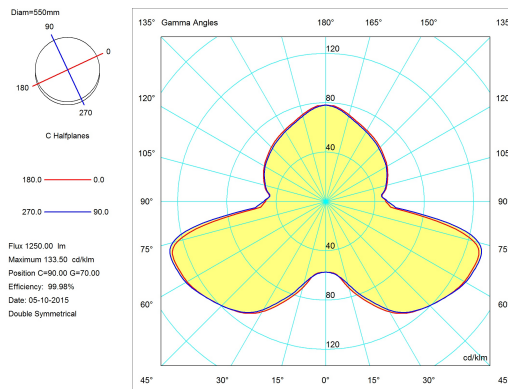
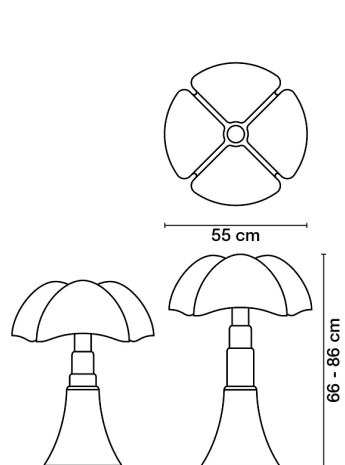

PIPISTRELLO LED

code: *620/DIM/L/1/CU*

DESIGN **GAE AULENTI** 1965

PHOTO GALLERY



PIPISTRELLO LED

code: **620/DIM/L/1/MA**

DESIGN **GAE AULENTI** 1965



TABLE OR STANDING LAMP WITH DIFFUSED LIGHT, ADJUSTABLE HEIGHT WITH TELESCOPIC MOVEMENT. GLAZED STAINLESS STEEL TELESCOPE. WHITE OPAL METHACRYLATE DIFFUSER. BASE AND KNOB: DARK BROWN /MA, WHITE /BI, PURPLE RED /RO, SATIN ALUMINIUM /AL, BRIGHT BLACK /NE - COPPER /CU, GOLD /ORO AND IN TITANIUM /TI COLOURS. LED LIGHT SOURCE INTEGRATED. ELECTRONIC DIMMABLE DRIVER ON THE PLUG.

TECHNICAL DRAWINGS

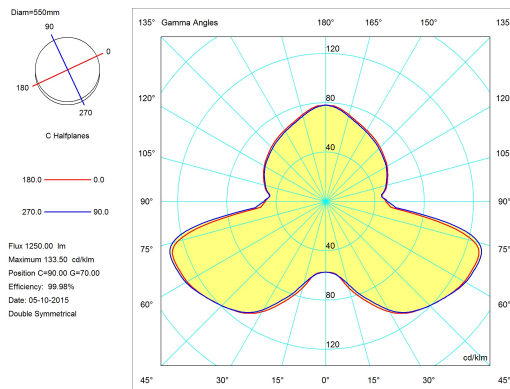
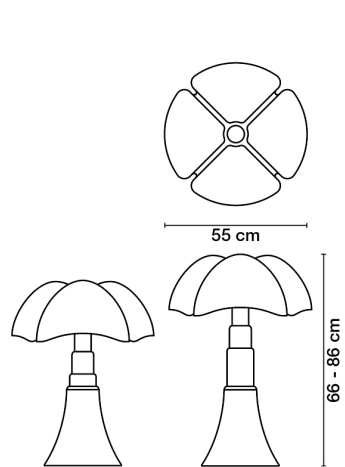

UTILIZATION:	INTERNAL	TIPOLOGY:	TABLE LAMPS	
COLOURS	STRUCTURE: DIFFUSER:	DARK BROWN WHITE		
MATERIALS	STRUCTURE: DIFFUSER:	STAINLESS STEEL OPAL WHITE METHACRYLATE		
MEASURES	WIDTH: - HEIGHT: 66 - 86 cm LENGTH: - DEPTH: -	DIAMETER: 55 cm HOLE DIAMETER: - HOLE DEPTH: -	WEIGHT NET: 10 KG GROSS: 14 KG	
	PACKAGING VOL.M ³ : 54X54X26 - 41X41X78	NUMBER OF ITEMS: 2		
BULBS	LED 1X14W FLUX: 1400LM KELVIN: 2700° CLASS: A++ CRI: - COLOR TOLERANCE: - DURATION: -			
				
DEVICE SPECIFICATIONS	TYPE OF EMISSION: DIFFUSED POWER: 14 W FLOW LAMP: 1249 lm BEAM ANGLE: - DEVICE EFFICIENCY: 89.2lm/W IMPACT RESISTANCE: - GLOW WIRE TEST: -		POWER SUPPLY CABLE LENGTH: 45+200cm LENGTH OF HANGING CABLE: - SUPPLY: INCLUDED POWER SUPPLY ASSEMBLY: EXTERNAL TYPE OF DIMMING: DIMMER ON CABLE VOLTAGE: 230 V	
	POWER SUPPLY: ELECTRONIC DIMMABLE POWER SUPPLY			
CERTIFICATIONS				
MARKETS	THIS ITEM IS AVAILABLE IN THE FOLLOWING COUNTRIES: EUROPE, USA & CANADA			

PIPISTRELLO LED

code: *620/DIM/L/1/MA*

DESIGN **GAE AULENTI** 1965

PHOTO GALLERY



PIPISTRELLO LED

code: **620/DIM/L/1/NE**







DESIGN 1965

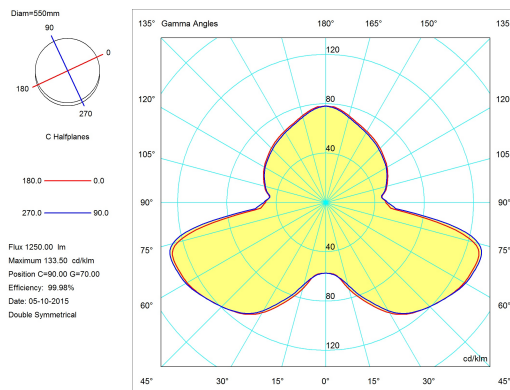
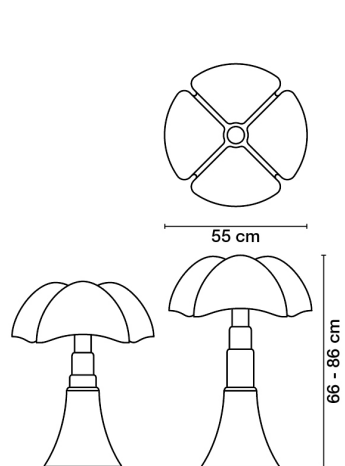

TABLE OR STANDING LAMP WITH DIFFUSED LIGHT, ADJUSTABLE HEIGHT WITH TELESCOPIC MOVEMENT. GLAZED STAINLESS STEEL TELESCOPE. WHITE OPAL METHACRYLATE DIFFUSER. BASE AND KNOB: DARK BROWN /MA, WHITE /BI, PURPLE RED /RO, SATIN ALUMINIUM /AL, BRIGHT BLACK /NE - COPPER /CU, GOLD /ORO AND IN TITANIUM /TI COLOURS. LED LIGHT SOURCE INTEGRATED. ELECTRONIC DIMMABLE DRIVER ON THE PLUG.

TECHNICAL DRAWINGS



UTILIZATION:	INTERNAL	TPOLOGY:	TABLE LAMPS	
COLOURS	STRUCTURE: DIFFUSER:	BLACK WHITE		
MATERIALS	STRUCTURE: DIFFUSER:	STAINLESS STEEL OPAL WHITE METHACRYLATE		
MEASURES	WIDTH: - HEIGHT: 66 - 86 cm LENGTH: - DEPTH: -	DIAMETER: 55 cm HOLE DIAMETER: - HOLE DEPTH: -	WEIGHT NET: 10 KG GROSS: 14 KG	
	PACKAGING VOL.M ³ : 54X54X26 - 41X41X78	NUMBER OF ITEMS: 2		
BULBS	LED 1X14W FLUX: 1400LM KELVIN: 2700° CLASS: A++ CRI: - COLOR TOLERANCE: - DURATION: -			
				
DEVICE SPECIFICATIONS	TYPE OF EMISSION: DIFFUSED POWER: 14 W FLOW LAMP: 1249 lm BEAM ANGLE: - DEVICE EFFICIENCY: 89.2lm/W IMPACT RESISTANCE: - GLOW WIRE TEST: -		POWER SUPPLY CABLE LENGTH: 45+200cm LENGTH OF HANGING CABLE: - SUPPLY: INCLUDED POWER SUPPLY ASSEMBLY: EXTERNAL TYPE OF DIMMING: DIMMER ON CABLE VOLTAGE: 230 V	
	POWER SUPPLY: ELECTRONIC DIMMABLE POWER SUPPLY			
CERTIFICATIONS	    			
MARKETS	THIS ITEM IS AVAILABLE IN THE FOLLOWING COUNTRIES: EUROPE, USA & CANADA			

PIPISTRELLO LED

code: *620/DIM/L/1/NE*

DESIGN 1965

PHOTO GALLERY









PIPISTRELLO LED

code: **620/DIM/L/1/RO**

DESIGN **GAE AULENTI** 1965



TABLE OR STANDING LAMP WITH DIFFUSED LIGHT, ADJUSTABLE HEIGHT WITH TELESCOPIC MOVEMENT. GLAZED STAINLESS STEEL TELESCOPE. WHITE OPAL METHACRYLATE DIFFUSER. BASE AND KNOB: DARK BROWN /MA, WHITE /BI, PURPLE RED /RO, SATIN ALUMINIUM /AL, BRIGHT BLACK /NE - COPPER /CU, GOLD /ORO AND IN TITANIUM /TI COLOURS. LED LIGHT SOURCE INTEGRATED. ELECTRONIC DIMMABLE DRIVER ON THE PLUG.

UTILIZATION:	INTERNAL	TPOLOGY:	TABLE LAMPS	
COLOURS	STRUCTURE: DIFFUSER:	PURPLE RED WHITE		
MATERIALS	STRUCTURE: DIFFUSER:	STAINLESS STEEL OPAL WHITE METHACRYLATE		
MEASURES	WIDTH: - HEIGHT: 66 - 86 cm LENGTH: - DEPTH: -	DIAMETER: 55 cm HOLE DIAMETER: - HOLE DEPTH: -	WEIGHT NET: 10 KG GROSS: 14 KG	
	PACKAGING VOL.M ³ : 54X54X26 - 41X41X78	NUMBER OF ITEMS: 2		
BULBS	LED 1X14W FLUX: 1400LM KELVIN: 2700° CLASS: A++ CRI: - COLOR TOLERANCE: - DURATION: -			
				
DEVICE SPECIFICATIONS	TYPE OF EMISSION: DIFFUSED POWER: 14 W FLOW LAMP: 1249 lm BEAM ANGLE: - DEVICE EFFICIENCY: 89.2lm/W IMPACT RESISTANCE: - GLOW WIRE TEST: -		POWER SUPPLY CABLE LENGTH: 45+200cm LENGTH OF HANGING CABLE: - SUPPLY: INCLUDED POWER SUPPLY ASSEMBLY: EXTERNAL TYPE OF DIMMING: DIMMER ON CABLE VOLTAGE: 230 V	
	POWER SUPPLY: ELECTRONIC DIMMABLE POWER SUPPLY			
CERTIFICATIONS	    			
MARKETS	THIS ITEM IS AVAILABLE IN THE FOLLOWING COUNTRIES: EUROPE, USA & CANADA			

TECHNICAL DRAWINGS

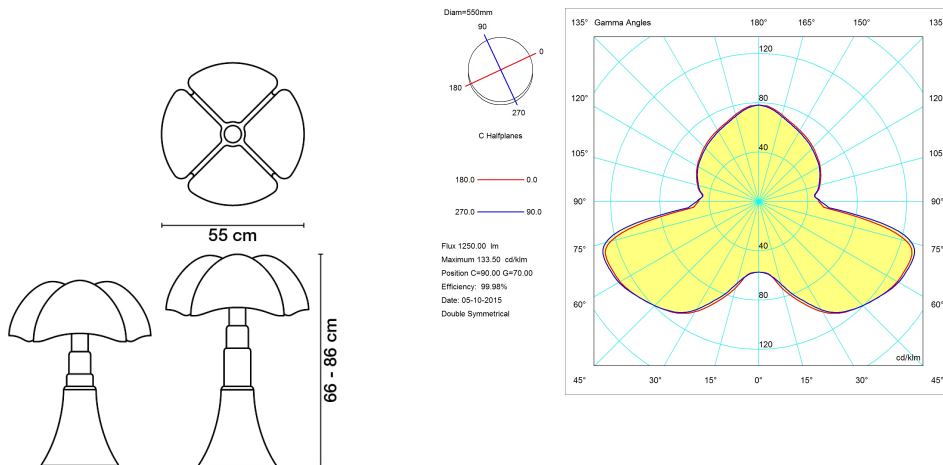

PIPISTRELLO LED

code: *620/DIM/L/1/RO*

DESIGN **GAE AULENTI** 1965

PHOTO GALLERY





PIPISTRELLO LED

code: **620/DIM/L/1/TI**

DESIGN **GAE AULENTI** 1965



TABLE OR STANDING LAMP WITH DIFFUSED LIGHT, ADJUSTABLE HEIGHT WITH TELESCOPIC MOVEMENT. GLAZED STAINLESS STEEL TELESCOPE. WHITE OPAL METHACRYLATE DIFFUSER. BASE AND KNOB: DARK BROWN /MA, WHITE /BI, PURPLE RED /RO, SATIN ALUMINIUM /AL, BRIGHT BLACK /NE - COPPER /CU, GOLD /ORO AND IN TITANIUM /TI COLOURS. LED LIGHT SOURCE INTEGRATED. ELECTRONIC DIMMABLE DRIVER ON THE PLUG.

UTILIZATION: INTERNAL		TPOLOGY: TABLE LAMPS 	
COLOURS	STRUCTURE: DIFFUSER:	TITANIUM WHITE	
MATERIALS	STRUCTURE: DIFFUSER:	STAINLESS STEEL OPAL WHITE METHACRYLATE	
MEASURES	WIDTH: -	DIAMETER: 55 cm	WEIGHT NET: 10 KG GROSS: 14 KG
	HEIGHT: 66 - 86 cm	HOLE DIAMETER: - HOLE DEPTH: -	
PACKAGING VOL.M ³ : 54X54X26 - 41X41X78			NUMBER OF ITEMS: 2
BULBS	LED 1X14W FLUX: 1400LM KELVIN: 2700° CLASS: A++ CRI: - COLOR TOLERANCE: - DURATION: -		
			
DEVICE SPECIFICATIONS		POWER SUPPLY CABLE LENGTH: 45+200cm	
TYPE OF EMISSION: DIFFUSED		LENGTH OF HANGING CABLE: -	
POWER: 14 W		SUPPLY: INCLUDED	
FLOW LAMP: 1249 lm		POWER SUPPLY ASSEMBLY: EXTERNAL	
BEAM ANGLE: -		TYPE OF DIMMING: DIMMER ON CABLE	
DEVICE EFFICIENCY: 89.2lm/W		VOLTAGE: 230 V	
IMPACT RESISTANCE: -			
GLOW WIRE TEST: -			
POWER SUPPLY: ELECTRONIC DIMMABLE POWER SUPPLY			
CERTIFICATIONS			
MARKETS	THIS ITEM IS AVAILABLE IN THE FOLLOWING COUNTRIES: EUROPE, USA & CANADA		

TECHNICAL DRAWINGS

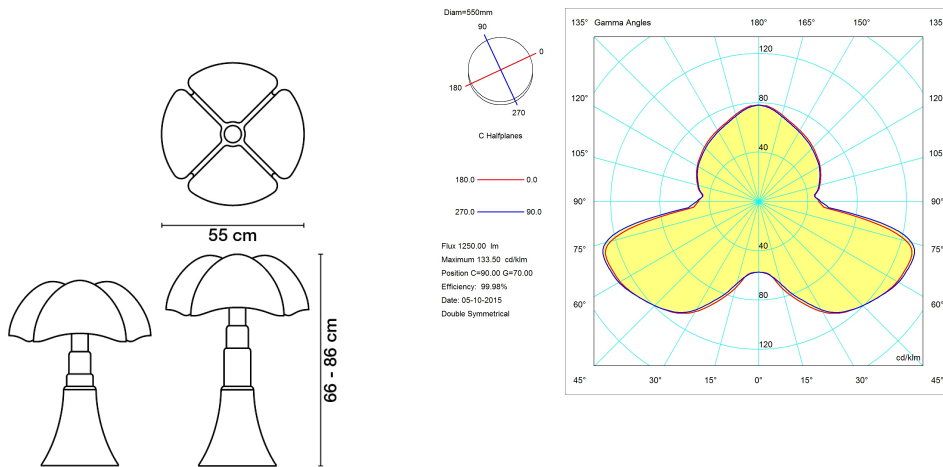

PIPISTRELLO LED

code: *620/DIM/L/1/TI*

DESIGN **GAE AULENTI** 1965

PHOTO GALLERY

